

**MSUD valve plug BI-11mm with cable**

PUR 3x0.75 gy UL/CSA+robot+drag ch. 3m

MSUD

Form BI (11 mm)

110 V AC/DC  $\pm 10\%$ 

LED and suppression

without cable sleeves

Further cable lengths on request.

Plastic housings with good resistance against chemicals and oils.

The resistance to aggressive media should be individually tested for your application. Further details on request.

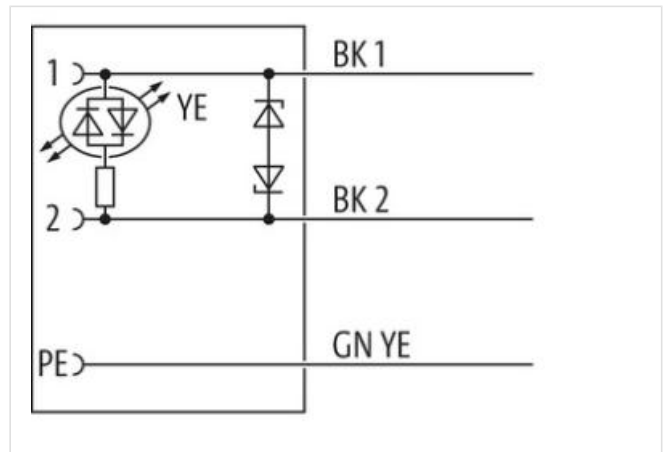
[Link naar het product](#)**Afbeelding**

Product van afwijken van afbeelding

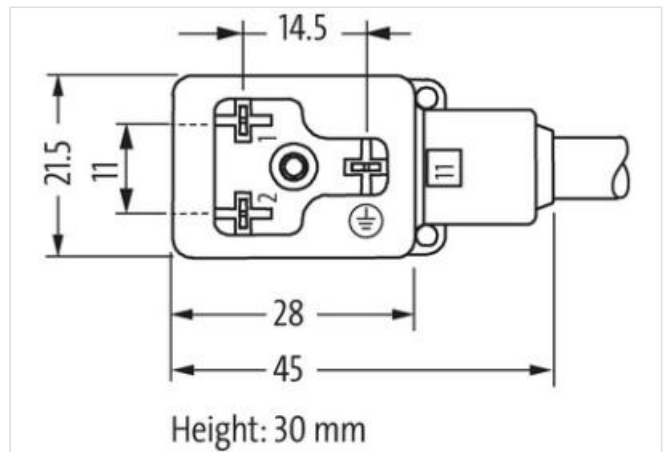

Cable length

3 m

**Side 1**

Tightening torque	0,4 Nm
Mounting method	inserted, screwed
Coating contact	silver-plated
Family construction form	MSUD BI
Thread	M3
Material contact	Copper alloy
Material	PBT
No. of poles	3
Degree of protection (EN IEC 60529)	IP67

**Side 2**

Coating contact	silver-plated
-----------------	---------------

**Electrical data**

Drop-out delay time max.	20 ms
--------------------------	-------

**Electrical data | Supply**

Operating voltage AC	110 V
Operating voltage AC min.	99 V
Operating voltage AC max.	121 V
Operating voltage DC	110 V
Operating voltage DC min.	99 V
Operating voltage DC max.	121 V
Cut-off peak voltage max.	270 V
Current operating per contact max.	4 A
Current consumption max.	8 mA

**Diagnostics**

Status indication LED	yellow
-----------------------	--------

**Installation | Connection**

Mounting set	M3
--------------	----

**Device protection | Electrical**

Additional condition protection degree	inserted, screwed
Pollution Degree	3
Rated surge voltage	2,5 kV
Material group (IEC 60664-1)	I
Additional suppressor	Diode, Z-Diode

**Mechanical data**

Contour for corrugated hose	without
-----------------------------	---------

**Mechanical data | Material data**

Coating locking	verzinkt
Coating of fitting	verzinkt
Color housing	black
Locking material	Steel
Material screw connection	Steel

**Mechanical data | Mounting data**

Mounting method	inserted, screwed
-----------------	-------------------

**Environmental characteristics | Climatic**

Operating temperature min.	-25 °C
Operating temperature max.	85 °C
Additional condition temperature range	depending on cable quality

**Important installation notes**

Note on strain relief	Protect the connectors by suitable measures from mechanical loads, e.g. by the usage of cable ties.
-----------------------	---

Note on bending radius

**Attention:** Observe the permissible bending radii when laying cables, as the IP protection class can be endangered by excessive bending forces.

Installation   Cable	
wire arrangement	black 1, black 2, green-yellow
Cable identification	256
Cable Type	5
Printing color of wire insulation	white (isolation black)
Jacket Color	gray
Type of Certificate	cURus
Amount stranding	1
Stranding	3 wires twisted
wire arrangement	black 1, black 2, green-yellow
Cable weight	48,4 g/m
Material jacket	PUR
Shore hardness jacket	58 ± 3 Shore D
Freedom from ingredients (jacket)	lead-free, cadmium-free, CFC-free, halogen-free, silicone-free
Outer-diameter (jacket)	5,2 mm
Tolerance outer diameter (sheath)	± 5 %
Material wire insulation	PP
Amount wires	3
Outer diameter insulation	1,7 mm
Outer diameter tolerance core insulation	± 5 %
Shore hardness wire insulation	74 ± 3 Shore D
Ingredient freeness wire insulation	lead-free, cadmium-free, CFC-free, halogen-free, silicone-free
Printing color of wire insulation	white (isolation black)
Amount strands (wire)	42
Diameter of single wires	0,15 mm
Conductor crosssection (wire)	0,75 mm <sup>2</sup>
Material conductor wire	Stranded copper wire, bare
Conductor type (wire)	strand class 6
Nominal voltage AC max.	300 V
Current load capacity (standard)	to DIN VDE 0298-4
Current load capacity min. wire	12 A
Electrical resistance line constant wire	26 Ω/km @ 20 °C
AC withstand voltage (wire - wire)	2,5 kV @ 60 s
Power frequency withstand voltage (wire - jacket)	2,5 kV @ 60 s
Min. operating temperature (static)	-40 °C
Max. operating temperature (fixed)	80 °C / 90 °C @ 10000 h Operation
Operating temperature min. (dynamic)	-25 °C
Operating temperature max. (dynamic)	80 °C / 90 °C @ 10000 h Operation
Flame resistance	UL 1581 § 1100 FT2   IEC 60332-2-2   UL 1581 § 1090
chemical resistance	Good, application-related testing
Gasoline resistance	Good, application-related testing
Oil resistance	Good, application-related testing   DIN EN 60811-404
Bending radius (fixed)	5 x Outer diameter
Bending radius (dynamic)	10 x Outer diameter
No. of bending cycles (C-track)	10 Mio. @ 25 °C
Traversing distance (C-track)	5 m @ 25 °C   horizontal
Travel speed (C-track)	3,3 m/s @ 25 °C
No. of torsion cycles	1 Mio.
Torsion stress	± 360 °/m
Torsion speed	35 cycles/min

#### Commerciële gegevens

De informatie in dit datablad is met de grootst mogelijke zorg samengesteld.  
Aansprakelijkheid beperkt tot grove nalatigheid voor de juistheid, volledigheid en actualiteit. Status: 2024-06-24

Murrelektronik bv | Noorderlaan 147-b9 | B-2030 Antwerpen | Fon +32 (0)380 868 81 | Fax | shop@murrelektronik.be | shop.murrelektronik.be

Douane tarief nummer	85444290
GTIN	4065909096895
Verpakkingseenheid	1