

7/8" male 0° with cable

PUR 5x1.0 gy 53m

Male straight

7/8" (5-pole)

Power cable

with cable sleeves

Further cable lengths on request.

Plastic housings with good resistance against chemicals and oils.

The resistance to aggressive media should be individually tested for your application. Further details on request.

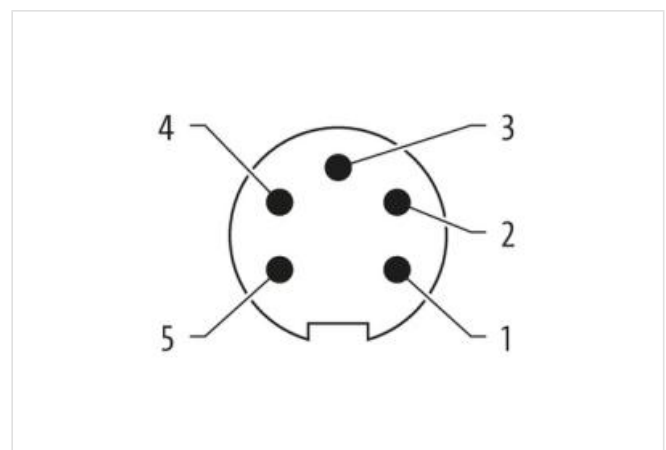
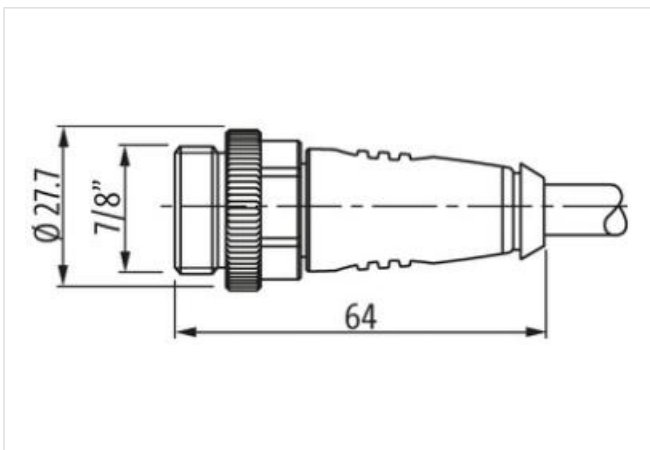
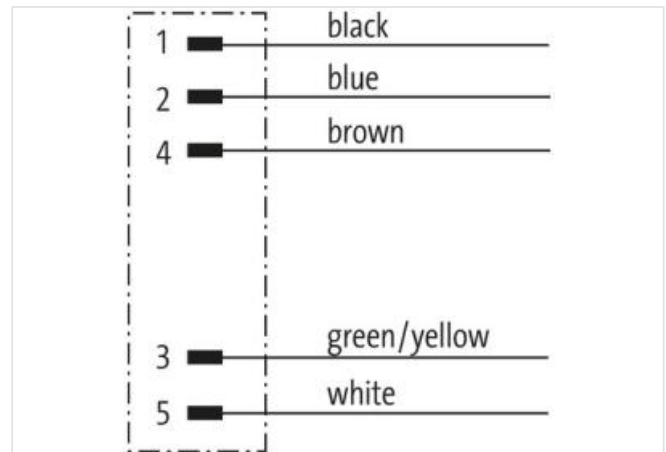
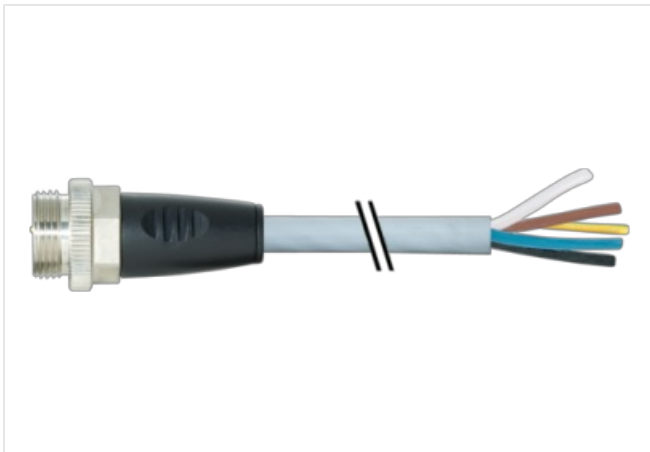
[Link naar het product](#)**Afbeelding**

Product van afwijken van afbeelding



Cable length 53 m

Side 1

Tightening torque 1,5 Nm

Family construction form	7/8"
Thread	7/8"
No. of poles	5
Width across flats	SW22

Commerciële gegevens

ECLASS-6.0	27279218
ECLASS-6.1	27279218
ECLASS-7.0	27279218
ECLASS-8.0	27279218
ECLASS-9.0	27060327
ECLASS-10.1	27060311
ECLASS-11.1	27060311
ECLASS-12.0	27060327
ETIM-5.0	EC001855
Douane tarief nummer	85444290
GTIN	4048879436762
Verpakkingseenheid	1

Electrical data | Supply

Current operating per contact max.	12 A
Current phase - neutral	230 V
Current phase - phase	400 V

Installation | Connection

Tightening torque	1,5 Nm
-------------------	--------

Device protection | Electrical

Degree of protection (EN IEC 60529)	IP67
Additional condition protection degree	inserted, screwed
Pollution Degree	3
Rated surge voltage	3 kV
Material group (IEC 60664-1)	I

Mechanical data | Mounting data

Mounting method	inserted, screwed, Shaking protection
-----------------	---------------------------------------

Environmental characteristics | Climatic

Operating temperature min.	-25 °C
Operating temperature max.	85 °C
Additional condition temperature range	depending on cable quality

Important installation notes

Note on strain relief	Protect the connectors by suitable measures from mechanical loads, e.g. by the usage of cable ties.
Note on bending radius	Attention: Observe the permissible bending radii when laying cables, as the IP protection class can be endangered by excessive bending forces.

Installation | Cable

wire arrangement	white 4, brown 3, green-yellow, blue 2, black 1
Cable identification	965
Printing color of wire insulation	black (white isolation), white (isolation black), black (isolation brown), black (insulation blue)
Jacket Color	gray
Amount stranding	1
Stranding	5 wires around Filler twisted
Filler	yes
wire arrangement	white 4, brown 3, green-yellow, blue 2, black 1
Cable weight	86,9 g/m
Material jacket	PUR
Shore hardness jacket	90 ± 5 Shore A

Freedom from ingredients (jacket)	lead-free, cadmium-free, CFC-free, silicone-free
Outer-diameter (jacket)	7,2 mm
Tolerance outer diameter (sheath)	± 5 %
Material inner jacket	PVC
Color (inner jacket)	gray
Material wire insulation	PP
Amount wires	5
Outer diameter insulation	2 mm
Outer diameter tolerance core insulation	± 5 %
Shore hardness wire insulation	60 ± 5 Shore D
Ingredient freeness wire insulation	lead-free, CFC-free, halogen-free
Printing color of wire insulation	black (white isolation), white (isolation black), black (isolation brown), black (insulation blue)
Amount strands (wire)	28
Diameter of single wires	0,205 mm
Conductor crosssection (wire)	1 mm ²
Material conductor wire	Stranded copper wire, bare
Conductor type (wire)	Strand class 5
Nominal voltage AC max.	600 V
Current load capacity (standard)	to DIN VDE 0298-4
Current load capacity min. wire	11,3 A
Electrical resistance line constant wire	19,5 Ω/km @ 20 °C
AC withstand voltage (wire - wire)	3 kV @ 60 s
Power frequency withstand voltage (wire - jacket)	3 kV @ 60 s
Min. operating temperature (static)	-30 °C
Max. operating temperature (fixed)	70 °C
Operating temperature min. (dynamic)	-5 °C
Operating temperature max. (dynamic)	70 °C
Flame resistance	IEC 60332-2-2 UL 1581 § 1100 FT2 UL 1581 § 1090
chemical resistance	Good, application-related testing
Gasoline resistance	Good, application-related testing
Oil resistance	Good, application-related testing DIN EN 60811-404
Bending radius (fixed)	7,5 x Outer diameter
Bending radius (dynamic)	10 x Outer diameter