

MQ15 female 0° with cable 600V AC type 3

PVC 4x2.5 bk UL/CSA 35m

Female straight

MQ15, 4-pole

with cable sleeves

Plastic housings with good resistance against chemicals and oils.

The resistance to aggressive media should be individually tested for your application. Further details on request.

Further cable lengths on request.

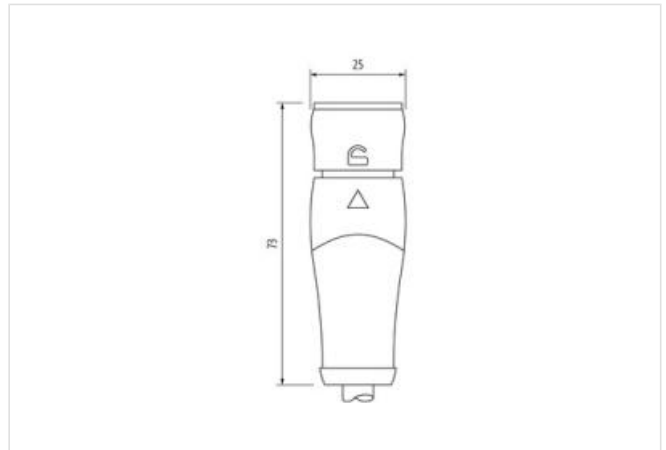
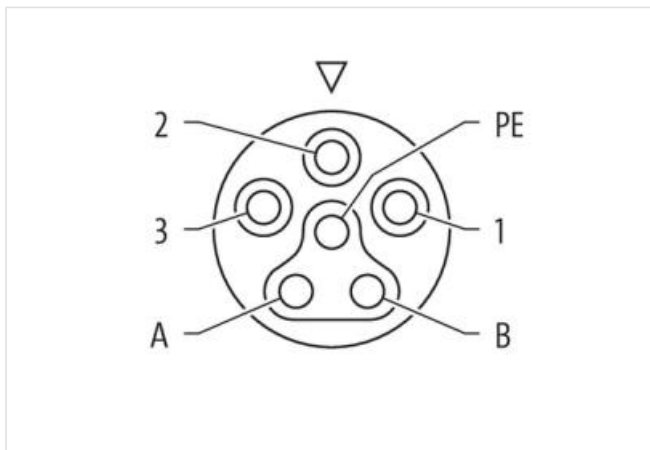
[Link naar het product](#)**Afbeelding**

Product van afwijken van afbeelding



Cable length

35 m

Side 1

Mounting method

inserted, locked

Coating contact	silver-plated
Family construction form	MQ15
suitable for corrugated tube (internal Ø)	18 mm
Cable outlet	straight
Coding	Type 3
Material contact	Copper alloy
No. of poles	4
Degree of protection (EN IEC 60529)	IP65, IP67

Side 2

Stripping length (jacket)	100 mm
---------------------------	--------

Commerciële gegevens

ECLASS-6.0	27279218
ECLASS-6.1	27279218
ECLASS-7.0	27279218
ECLASS-8.0	27279218
ECLASS-9.0	27060327
ECLASS-10.1	27060311
ECLASS-11.1	27060311
ECLASS-12.0	27060327
ETIM-5.0	EC001855
Douane tarief nummer	85444290
GTIN	4048879908078
Verpakkingseenheid	1

Electrical data | Supply

Operating voltage AC max.	600 V
Current operating per contact max.	16 A

Diagnostics

Status indication LED	no
-----------------------	----

Installation | Connection

Stripping length (jacket)	100 mm
---------------------------	--------

Installation | Pin assignment

Coding	Type 3
Configuration	partly used

Device protection | Electrical

Additional condition protection degree	inserted, locked
Pollution Degree	3
Rated surge voltage	6 kV
Material group (IEC 60664-1)	I

Mechanical data | Material data

Material housing	PUR
Material contact carrier	PA
Locking material	POM

Mechanical data | Mounting data

Looking techniques	bayonet-locking
--------------------	-----------------

Environmental characteristics | Climatic

Operating temperature min.	-30 °C
Operating temperature max.	85 °C
Additional condition temperature range	depending on cable quality

Important installation notes

Note on strain relief Protect the connectors by suitable measures from mechanical loads, e.g. by the usage of cable ties.

Note on bending radius **Attention:** Observe the permissible bending radii when laying cables, as the IP protection class can be endangered by excessive bending forces.

Conformity

Product standard IEC 61076-2-116

Installation | Cable

wire arrangement	black 3, black 2, black 1, green-yellow
Cable identification	P72
Cable Type	1
Function cable	Power
Printing color of wire insulation	white (isolation black)
Jacket Color	black
Type of Certificate	cURus
Amount stranding	1
Stranding	4 wires twisted
wire arrangement	black 3, black 2, black 1, green-yellow
Cable weight	167,75 g/m
Material jacket	PVC
Shore hardness jacket	90 ± 5 Shore A
Freedom from ingredients (jacket)	lead-free, cadmium-free, CFC-free
Outer-diameter (jacket)	8,8 mm
Tolerance outer diameter (sheath)	± 5 %
Material wire insulation	PP
Amount wires	4
Outer diameter insulation	2,85 mm
Outer diameter tolerance core insulation	± 5 %
Shore hardness wire insulation	60 ± 5 Shore D
Ingredient freeness wire insulation	lead-free, cadmium-free, CFC-free, halogen-free, silicone-free
Printing color of wire insulation	white (isolation black)
Amount strands (wire)	140
Diameter of single wires	0,15 mm
Conductor crosssection (wire)	2,5 mm ²
Material conductor wire	Stranded copper wire, bare
Conductor type (wire)	strand class 6
Electrical function wire	Power
Nominal voltage AC max.	1000 V
Current load capacity (standard)	to DIN VDE 0298-4
Current load capacity min. wire	20,8 A
Electrical function wire	Power
Electrical resistance line constant wire	8 Ω/km @ 20 °C
AC withstand voltage (wire - wire)	10 kV
Power frequency withstand voltage (wire - jacket)	10 kV
Min. operating temperature (static)	-40 °C
Max. operating temperature (fixed)	80 °C
Operating temperature min. (dynamic)	-25 °C
Operating temperature max. (dynamic)	80 °C
UV resistance	DIN EN ISO 4892-2 A
Flame resistance	UL 1581 § 1090 UL 1581 § 1100 FT2 IEC 60332-2-2
chemical resistance	Good, application-related testing
Gasoline resistance	Good, application-related testing
Oil resistance	DIN EN 60811-404 Good, application-related testing
Bending radius (fixed)	5 x Outer diameter
Bending radius (dynamic)	10 x Outer diameter

